

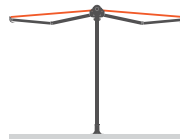

GAMME GREMAT

1 GREMAT JADE



2 GREMAT JADE LUX



+ **LED**

3 GREMAT ON'X



+

4 GREMAT ON'X LUX

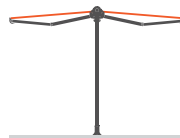

+ **LED**

 FABRIQUÉ EN FRANCE

- GARANTIE 5 ANS : ARMATURE, MOTEUR ET TOILE -
- GARANTIE 1 AN : LED -

GAMME GREMAT

-GARANTIE 5 ANS -

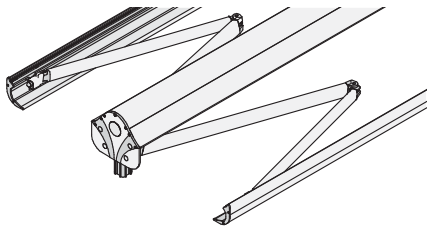

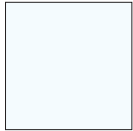

COFFRE

- COFFRE en aluminium extrudé, compact équipé de joues latérales en aluminium.
- TUBE D'ENROULEMENT : $\varnothing 78$ mm rainuré.
- BARRE DE CHARGE en aluminium extrudé, joues en aluminium moulé laqué.



COLORIS D'ARMATURE

-  RAL 9016 Blanc
-  FS 7016 Gris Anthracite
-  D'autres coloris sont disponibles en plus-values.



GRENAT ON'X



GRENAT JADE

BRAS

- GRENAT ON'X, aluminium, muni d'un système Forty.
- Bras testés à 80 000 cycles.
- GRENAT JADE, aluminium, muni d'un double câble gainé. Bras testés à 20 000 cycles.



MOTORISATION

Par moteur SOMFY radio SUNEa io avec une télécommande portable.

OPTION :

Manœuvre par treuil et manivelle décrochable (pour le modèle sans éclairage).



TOILE DU STORE

Toiles Groupe A - groupe B - acryliques **uniquement** choix de coloris illimité.

LED

ÉCLAIRAGE | LUX (garantie 1 an)

- GRENAT ON'X LUX : Double éclairage intégré dans les bras sur la totalité de l'avancée et dans la sous-face du coffre (partie centrale).
- GRENAT JADE LUX : Éclairage intégré dans la sous-face du coffre (partie centrale).

TYPE DE PIEDS

Kit de piétement en aluminium moulé laqué $\varnothing 78$ mm rainuré, au choix parmi les modèles A ou B.

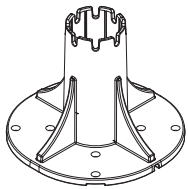

$\varnothing = 270$ mm
H = 212 mm

TYPE A (standard)

FIXATION AU SOL

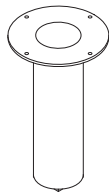

$\varnothing = 160$ mm
H = 300 mm

TYPE B (sans + values)

À ENTERRER

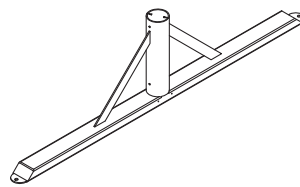

L = 1500 mm
H = 390 mm

TYPE C (+)

POSE AU SOL

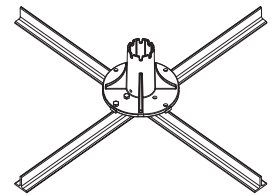

L = 1200 mm
H = 245 mm

TYPE D (+)

MAINTIEN PAR DALLES

CARACTÉRISTIQUES TECHNIQUES

DIMENSIONS	GRENAT ON'X	GRENAT ON'X LUX	GRENAT JADE	GRENAT JADE LUX
Largeur mini	1930 mm	1930 mm	1640 mm	1640 mm
Largeur maxi	5980 mm	5980 mm	4810 mm	4810 mm
Avancée mini	1500 mm (x2)	1500 mm (x2)	1500 mm (x2)	1500 mm (x2)
Avancée maxi	3000 mm (x2)	3000 mm (x2)	2500 mm (x2)	2500 mm (x2)

ENCOMBREMENT

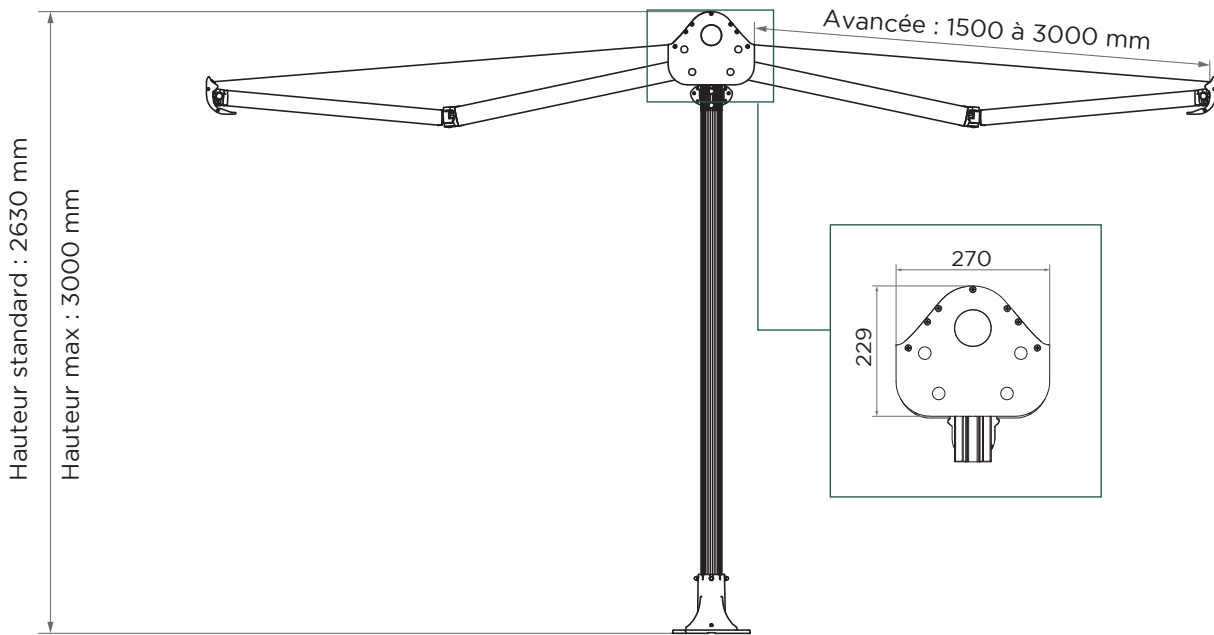

INCLINAISON

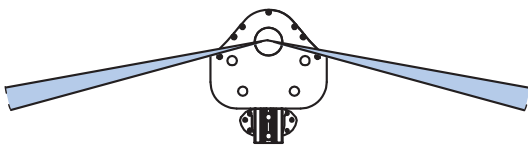

Angle 10° à 25° : Plage de garantie pour les avancées de 1500 mm à 3000 mm.

CARACTÉRISTIQUES OPTIONNELLES

LAMBREQUIN

Amovible - livrable en 5 découpes - hauteur 220 mm - coloris au choix avec galon assorti



Forme n°1
Droit



Forme n°2
Vagues



Forme n°3
Créneaux



Forme n°4
Demi-lune



Forme n°5
Victoria

LAQUAGE

Coloris au choix suivant nuancier Marques Colors ou Structurés. Nuancier disponible à la p.18 et 19.

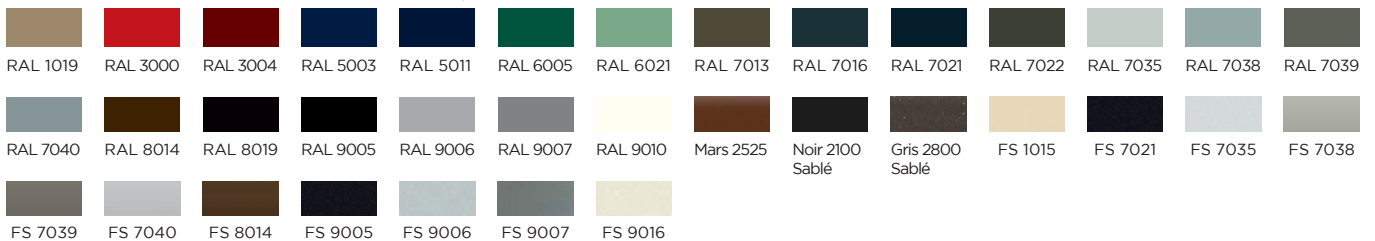

AUTOMATISMES



CAPTEUR SOLEIL
Kit Sunis II io et
Situio 5 VAR A/M io



Eolis Wirefree io



Existe en coloris : crème, noir et blanc

CAPTEUR VENT IO

Eolis 3D Wirefree io



Existe en coloris : noir ou blanc

RAMPE DE CHAUFFAGE io

On/Off